

# CARPLAY User's Manual



# CARPLAY English Manual

Thank you for purchasing the motorcycle CARPLAY. This manual will go over how to properly use the device and provide you with detailed product information regarding operation, precautions, and technical data. Please read this manual carefully.

## **Disclaimer**

The motorcycle CARPLAY is provided as is and the recording videos is only for reference, the final adjudication will be judged by the police officer. The terms and conditions are subject to change at any time without prior notice

## **Important Notices**

1. Avoid exposing this product to alcohol, oils, or other chemicals to prevent damage to the waterproof structure.
2. This product supports IP67 waterproof rating, but avoid direct contact with high-pressure water jets.
3. Before installing this product, turn off the motorcycle's power. Find the optimal location to secure the device before turning the power back on.

## **Product Features**

1. 5.5-inch large touch screen for easy control
2. IP67 waterproof: Ride in any weather!
3. Wireless display for hassle-free connection
4. Dual satellite GPS & BDS system for accurate navigation
5. Compatible with iOS, Android Auto, and Huawei HiCar
6. 1100 nits brightness: Crystal-clear even in bright sunlight!

## Product Structure

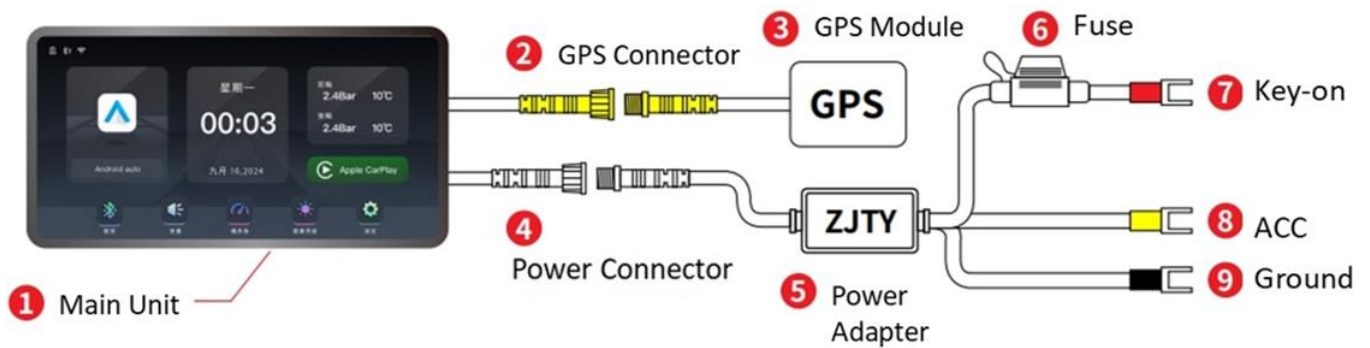

Notices: During installation, please match wires according to their labels and colors.

## Bracket Instructions

### Universal Bracket:

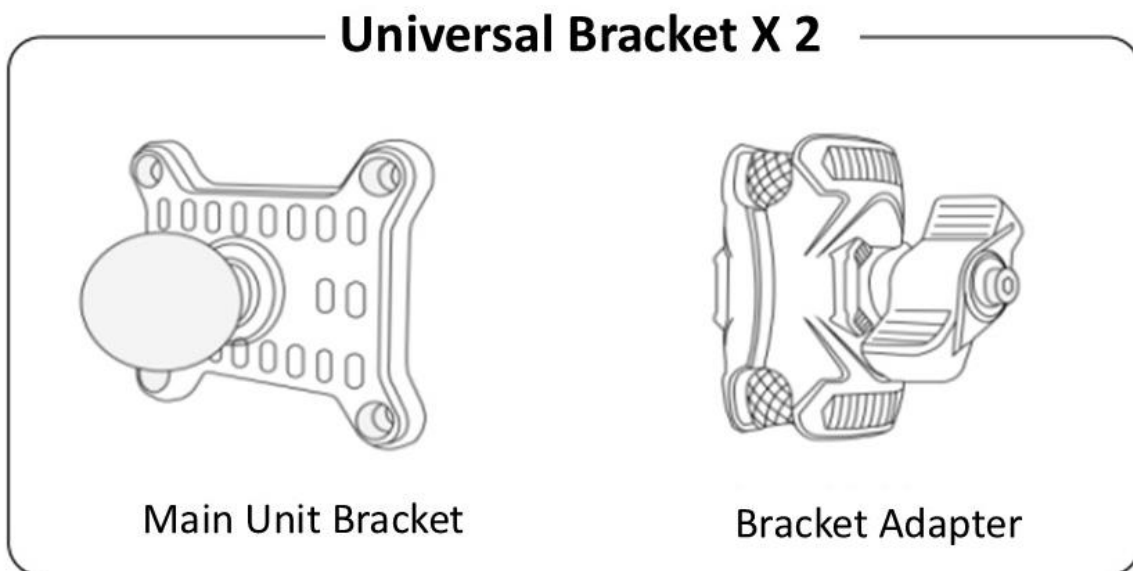

- **Main Unit Bracket:** Secure it to the back of the main unit using four screws.
- **Bracket Adapter:** Attach between the main unit and either the ball joint bracket or the rearview mirror bracket.

## Optional Bracket:

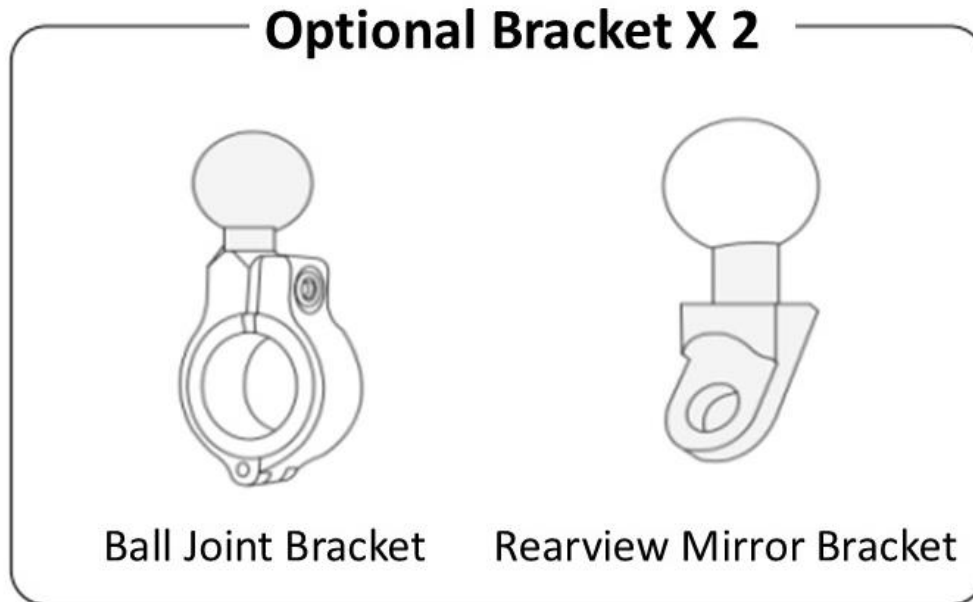

- **Ball Joint Bracket:** Mount on the motorcycle handlebar (includes three sizes of washers to fit various handlebar diameters).
- **Rearview Mirror Bracket:** Secure to the lock hole at the base of the motorcycle rearview mirror.

## Main Interface Description















## Dashboard Interface Description



## System Settings Interface Description



1.		GPS :	View GPS Connection Status: Check latitude, longitude, time, and speed data.
2.		Language :	Multi-language Support: Options for Traditional Chinese, English, and other languages.
3.		Time :	Manual adjustment of time zone, date, and time.
4.	<b>24H</b>	Time Format :	12-hour/24-hour Time Format
5.		Brightness / Volume :	Manual/automatic brightness settings and volume control.
6.		Tire Pressure :	Tire Pressure, Temperature, and Alert Settings
7.		Screen Saver :	Automatic Screen Sleep Mode: Options for Off, 1 minute, 3 minutes, or 5 minutes.
8.		Text Tone :	On / Off Setting
9.		Boot Sound :	On / Off Setting
10.		SD Card Format :	For system firmware updates only; do not operate unnecessarily.
11.		Reset Presets :	Restore Factory Settings
12.		Audio :	Sound Output Setting: Choose between device or phone for audio output.
13.		About :	Device-related information

## **Wireless Screen Casting Connection Instructions**

1. Supports Screen Casting for CarPlay (Apple), Android Auto(Android), and HiCar (Huawei) systems.
2. Before operating, go to the main interface's screen casting settings and select the appropriate system for your mobile device.
3. Some phones and models do not support screen casting. Please confirm compatibility with your mobile provider before purchasing.

### **a. Connecting CarPlay:**

- **I.** For the first connection, enable Bluetooth on your phone and connect to the device's Bluetooth (check the Bluetooth name on the Bluetooth main interface). Wait 5-10 seconds.
  
- **II.** Select the pop-up on your phone to use CarPlay. After successful Bluetooth pairing, the Bluetooth will automatically disconnect, and the CarPlay interface will be transmitted automatically. For future connections, the device will automatically reconnect when both Bluetooth and Wi-Fi are enabled on your phone, without any additional action.
  
- **III.** Due to iOS system version differences, do not manually connect to the device's Wi-Fi. If you encounter connection issues, manually forget the connected device's Wi-Fi, then reconnect via Bluetooth.

### **b. Connecting Android Auto:**

- **I.** For the first connection, open the settings menu, select "Phone Interconnect" -> Choose "Android Auto" -> Enable Bluetooth on your phone and connect to the device's Bluetooth (check the Bluetooth name on the Bluetooth main interface). Wait 5-10 seconds. When Wi-Fi is enabled on your phone, the Android Auto interface will automatically transmit.

### **c. Connecting HiCar:**

- **I.** Ensure Bluetooth is enabled on your phone, and follow the prompts on both the phone and device interfaces.

## Screen Casting Interface Description

The screen casting display interface may vary depending on the Apps installed on the user's mobile device. Not all Apps support screen casting functionality.



**Home button icon**  
Also displays current speed



### **Shortcuts:**

Click to adjust screen brightness,  
volume, screen lock and return  
to the main menu functions

## **Tire Pressure Detection (Optional)**

1. Accessories: 2 External Sensors, 2 Anti-theft Screws, 1 Hex Wrench
2. Installation Method:
  - A. Start the motorcycle -> Enter the main unit system settings interface -> Select the “Tire Pressure Settings” option.
  - B. Screw the anti-theft screws onto the front and rear tire valves.
  - C. In the tire pressure settings interface, click the “Pair” icon for the sensors located at the bottom left.
  - D. Screw the sensors onto the front and rear tire valves  
(make sure to match the sensors marked with F (Front) and R (Rear)).
  - E. Check if the tire pressure settings interface shows the tire pressure and temperature values for both the front and rear wheels. The normal tire pressure range is 28-42 Psi  
(except for specific motorcycle models).
  - F. Use the hex wrench to tighten the anti-theft washers and sensors, completing the installation.

## **Accessories**

Main Unit x 1

GPS x 1

ACC Power Cord x 1

Main Unit Bracket x 1 (contains 5 metal screws)

Bracket Adapter x 1

Ball Joint Bracket x 1 (contains 3 sizes of washers)

Rearview Mirror Bracket x 1

Main Unit Metal Cover Spare Screws x 2

Tie Strap, Screwdriver x 1

Hex Wrench x 3 (different sizes)

Lens Cleaning Cloth x 1

## Product Specification

Brand	LOOKING
Model type	CARPLAY
Screen size	5.5-inch touch screen (1440 x 720)
IP Rating	IP67
Screen Brightness	1100 nits
Device System	CGOS (Linux)
Internal speaker	8w High performance speakers
Bluetooth	5.2 BLE
WiFi	5G WiFi (9M/s)
Working Temperature	-20°C ~ 70°C
GNSS	GPS +BDS dual module system
Power Supply	DC 5V / 2A (Max)
Mobile Phone Screen Casting	Support Carplay (Apple), Android Auto (Android), Hicar (Huawei)
Host Dimension	142.5 x 78.9 x 16.9 mm
Host Weight	267 g
Tire Pressure Detection	Optional

## **Q & A**

**Q: How to disconnect CarPlay/Android Auto/HiCar?**

A: Simply turn off the mobile phone's Wi-Fi or forget the device on Bluetooth.

**Q: After manually disconnecting CarPlay/Android Auto/HiCar, how to reconnect?**

A: Reconnect by tapping the Bluetooth device on your mobile phone.

**Q: After the device powers off and restarts, how to reconnect CarPlay/Android Auto/HiCar?**

A: If your phone has previously connected to the device, it will automatically reconnect when both Bluetooth and Wi-Fi are enabled on your phone.

If you need any further assistance, please email to [sales@lookingtaiwan.com](mailto:sales@lookingtaiwan.com).

THANK YOU!